

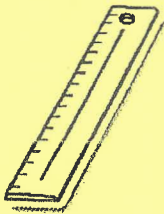





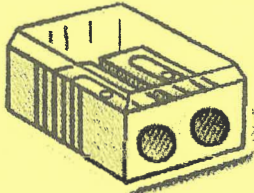

循理會白普理基金循理小學

姓名： <u>曾泊鎰</u> (21)	一年級下學期數學科	成績	3 3
班別：1 <u>A</u>	課題：硬幣的使用		
日期： <u>4-5-2021</u>			

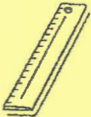
1. 下面是文具店內一些文具的售價。



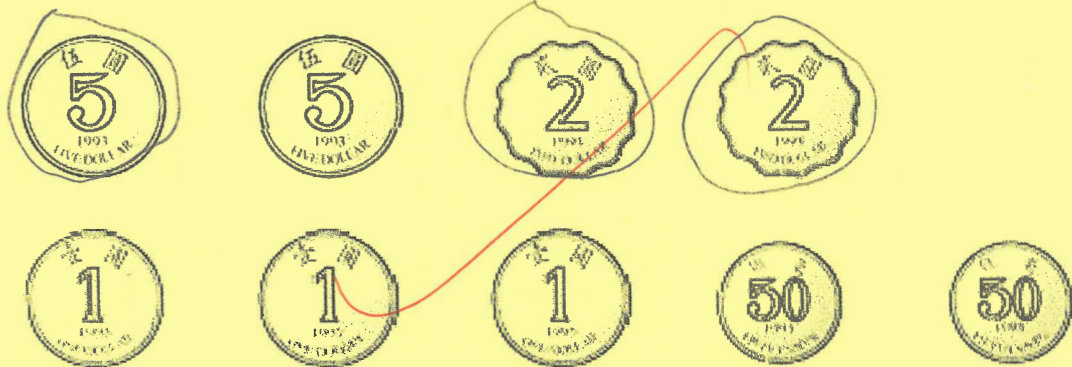

			
\$3.00	\$4.00	\$7.00	\$9.00

2. 我要買一件 ( /  /  / ) 【圈出物品】

圈出要付的硬幣：

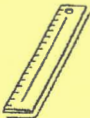

需付 9 元。

3. 哥哥原有 18 元，買了一件 ( /  /  / ) 後，

還有 (9) 元。





循理會白普理基金循理小學

非常
非常好
非常好

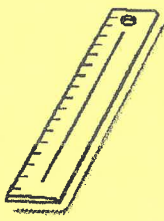
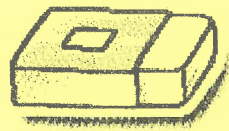
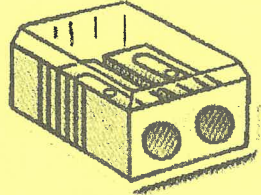
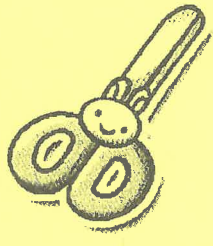
姓名： <u>楊浩明</u> (24)	一年級下學期數學科	成績	3 3 5/5
班別：1 <u>A</u>	課題：硬幣的使用	成績	
日期： <u>4-5-2021</u>			

1. 下面是文具店內一些文具的售價。

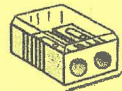

			
\$3.00	\$4.00	\$7.00	\$9.00

2. 我要買一件 ( /  /  / ) 【圈出物品】

圈出要付的硬幣：

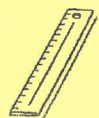
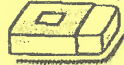
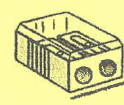

需付 3 元。

3. 哥哥原有 18 元，買了一件 ( /  /  / ) 後，
還有 (9) 元。

循理會白普理基金循理小學

姓名： <u>陳康悠</u> (2)	一年級下學期數學科	成績	
班別：1 <u>B</u>	課題：硬幣的使用		
日期： <u>7-5-2021</u>			

1. 下面是文具店內一些文具的售價。

\$3.00	\$4.00	\$7.00	\$9.00

2. 我要買一件 (/ / /) 【圈出物品】

圈出要付的硬幣：

需付 9 元。

★ 3. 哥哥原有 18 元，買了一件 (/ / /) 後，
還有 (15) 元。

循理會白普理基金循理小學

姓名： <u>周素蓮</u> (4) 班別：1 <u>B</u> 日期： <u>7-5-2021</u>	一年級下學期數學科 課題：硬幣的使用	成績	
--	-----------------------	----	---

1. 下面是文具店內一些文具的售價。

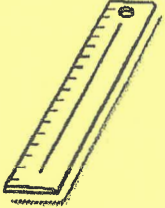
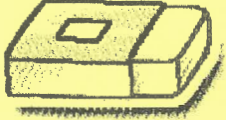
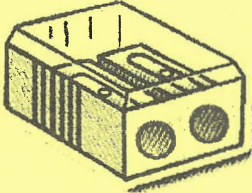
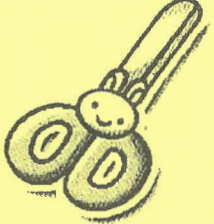



			
\$3.00	\$4.00	\$7.00	\$9.00

2. 我要買一件 ( /  /  / ) 【圈出物品】

圈出要付的硬幣：

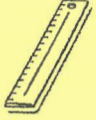



需付 9 元。



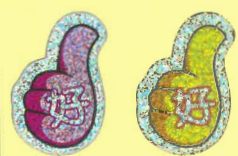

3. 哥哥原有 18 元，買了一件 ( /  /  / ) 後，
還有 (9) 元。

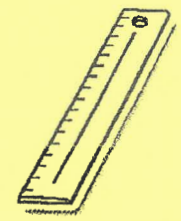
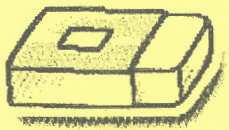
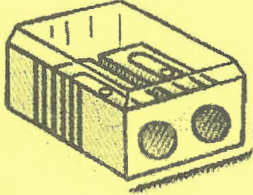
循理會白普理基金循理小學

姓名： <u>高梓 王林 (8)</u> 班別：1 <u>B</u> 日期： <u>7-5-2021</u>	一年級下學期數學科 課題：硬幣的使用	成績	
--	-----------------------	----	---

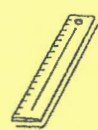
1. 下面是文具店內一些文具的售價。

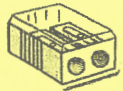

			
\$3.00	\$4.00	\$7.00	\$9.00

2. 我要買一件 ( /  /  / ) 【圈出物品】

圈出要付的硬幣：



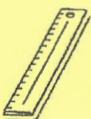
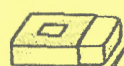
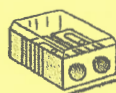



需付 9 元。

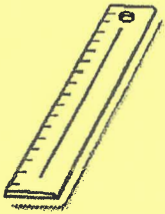

3. 哥哥原有 18 元，買了一件 ( /  /  / ) 後，

還有 (9) 元。

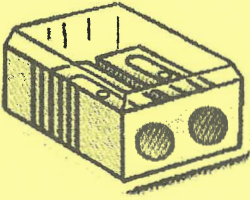
姓名： <u>葉朗軒</u> (28)	一年級下學期數學科	成績	A 5/5
班別：1 <u>C</u>	課題：硬幣的使用		
日期： <u>4-5-2021</u>			

1. 下面是文具店內一些文具的售價。

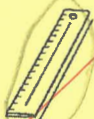
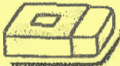
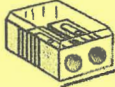
			
\$3.00	\$4.00	\$7.00	\$9.00

2. 我要買一件 ( /  /  / ) 【圈出物品】

圈出要付的硬幣：







需付 3 元。

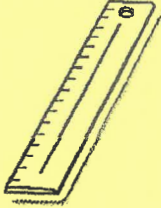

3. 哥哥原有 18 元，買了一件 ( /  /  / ) 後，

還有 (15) 元。

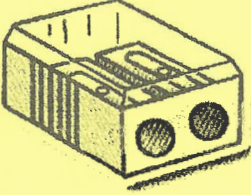
姓名: <u>劉凱晴</u> (15)	一年級下學期數學科	成績	A
班別: 1 <u>C</u>	課題: 硬幣的使用		
日期: <u>4-5-2021</u>			

1. 下面是文具店內一些文具的售價。

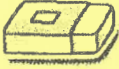
			
\$3.00	\$4.00	\$7.00	\$9.00

2. 我要買一件 ( /  /  / ) 【圈出物品】

圈出要付的硬幣：



需付 7 元。



3. 哥哥原有 18 元，買了一件 ( /  /  / ) 後，

還有 (11) 元。

循理會白普理基金循理小學

姓名： <u>楊志樂</u> (25) 班別：1 日期： <u>4-5-2021</u>	一年級下學期數學科 課題：硬幣的使用	成績	A
--	-----------------------	----	---

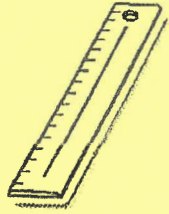
1. 下面是文具店內一些文具的售價。

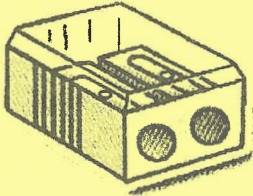
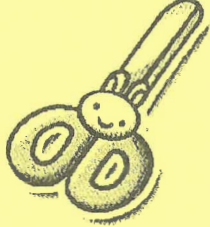
			
\$3.00	\$4.00	\$7.00	\$9.00

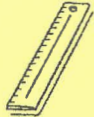
2. 我要買一件 ( /  /  / ) 【圈出物品】

圈出要付的硬幣：



需付 9 元。





3. 哥哥原有 18 元，買了一件 ( /  /  / ) 後，



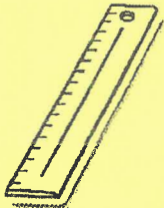

還有 (9) 元。

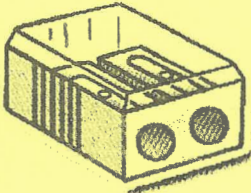
循理會白普理基金循理小學

姓名： <u>鄧靖棠</u> (26)	一年級下學期數學科 課題：硬幣的使用	成績	<u>3</u> <hr/> <u>3</u>
班別：1 <u>D</u>			
日期： <u>6-5-2021</u>			

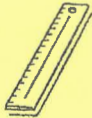
1. 下面是文具店內一些文具的售價。





			
\$3.00	\$4.00	\$7.00	\$9.00

2. 我要買一件 ( /  /  / ) 【圈出物品】

圈出要付的硬幣：



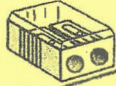

需付 7 元。



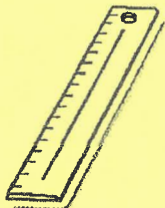
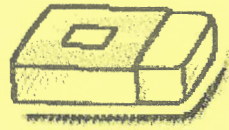
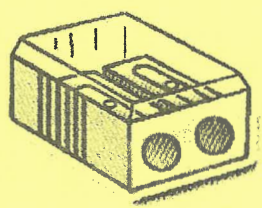

3. 哥哥原有 18 元，買了一件 ( /  /  / ) 後，
還有 (14) 元。

循理會白普理基金循理小學

姓名： <u>宋仁杰</u> (18)	一年級下學期數學科	成績	<u>3</u> 3
班別：1 <u>0</u>	課題：硬幣的使用		
日期： <u>6-5-2021</u>			

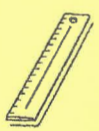
1. 下面是文具店內一些文具的售價。

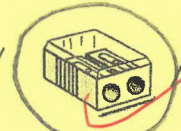



			
\$3.00	\$4.00	\$7.00	\$9.00

2. 我要買一件 ( /  /  / ) 【圈出物品】

圈出要付的硬幣：

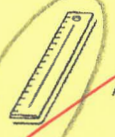

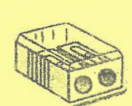

需付 7 元。



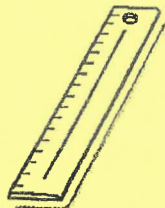
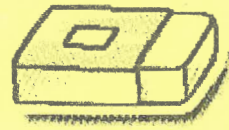
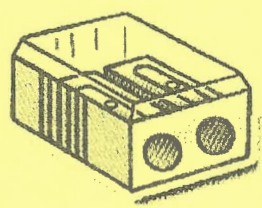

3. 哥哥原有 18 元，買了一件 ( /  /  / ) 後，
還有 (15) 元。

循理會白普理基金循理小學

姓名： <u>羅志玥</u> (7)	一年級下學期數學科 課題：硬幣的使用	成績	<u>3</u> <hr/> <u>3</u>
班別：1 <u>10</u>			
日期： <u>6-5-2021</u>			

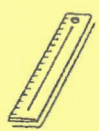
1. 下面是文具店內一些文具的售價。

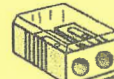

			
\$3.00	\$4.00	\$7.00	\$9.00

2. 我要買一件 ( /  /  / ) 【圈出物品】

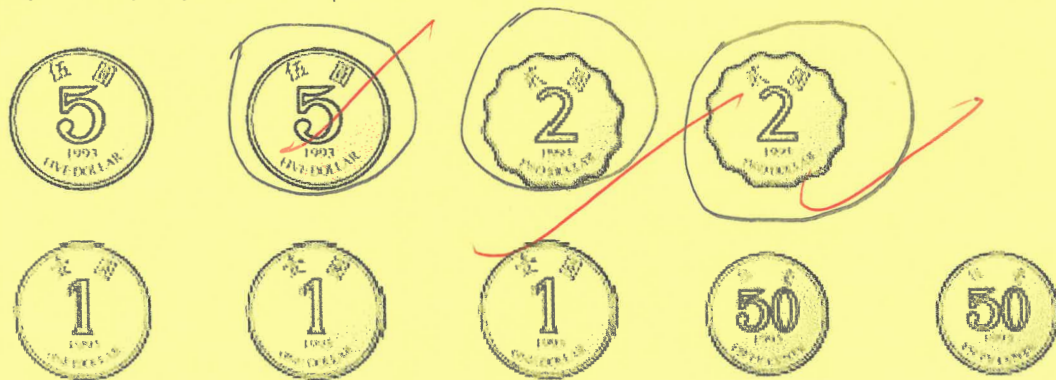
圈出要付的硬幣：



需付 9 元。

3. 哥哥原有 18 元，買了一件 ( /  /  / ) 後，



還有 (14) 元。

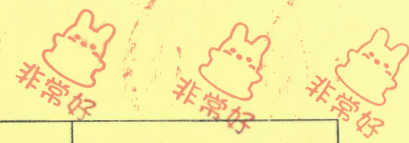



①

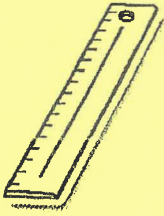

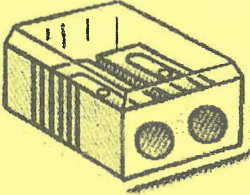
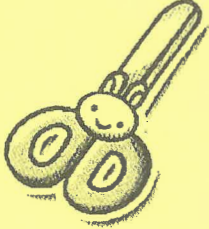
姓名： <u>鄭牧風</u> (9)	一年級下學期數學科	成績	3 — 3 5/5
班別：1 <u>A</u>	課題：硬幣的使用		
日期： <u>4-5-2021</u>			

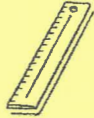
1. 下面是文具店內一些文具的售價。

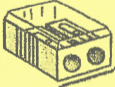



			
\$3.00	\$4.00	\$7.00	\$9.00

2. 我要買一件 ( /  /  / ) 【圈出物品】

圈出要付的硬幣：

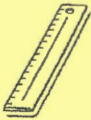

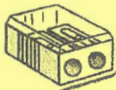
需付 9 元。

3. 哥哥原有 18 元，買了一件 ( /  /  / ) 後，

還有 (9) 元。